

Навесная фасадная система с вентилируемым воздушным зазором

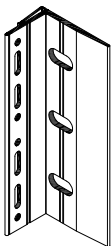

AK-40Б



AK-65Б

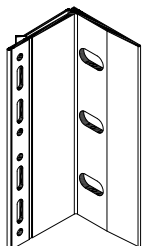

AK-80Б

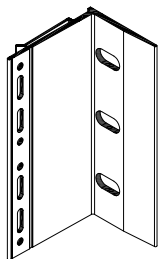

AK-120Б

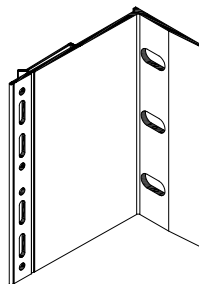

AK-140Б

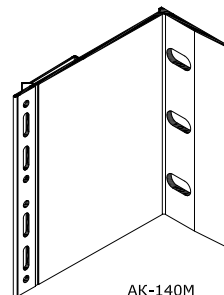

AK-40М

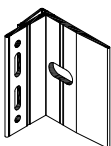

AK-65М

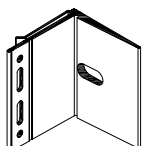

AK-80М

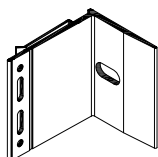

AK-120М

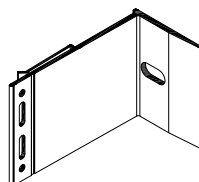

AK-140М

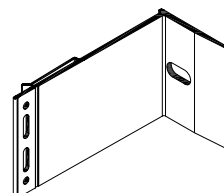

AK-170Б

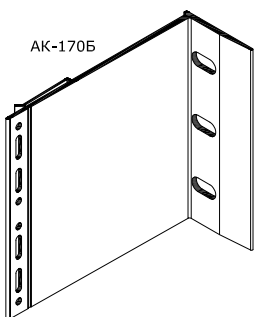

AK-190Б

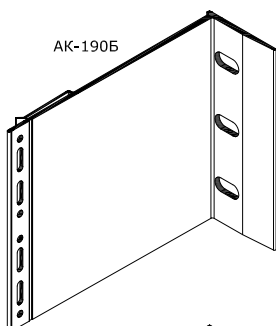

AK-220Б

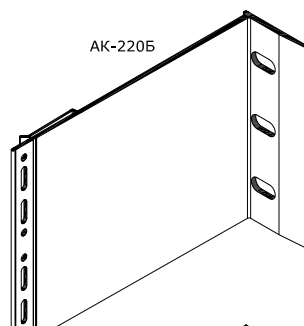

УК-Б

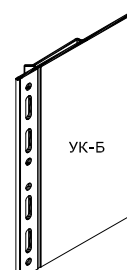

AK-170М

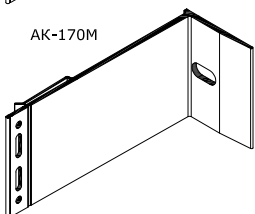

AK-190М

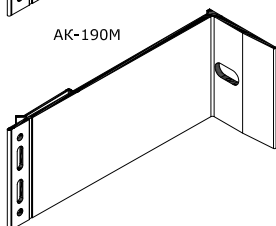

AK-220М

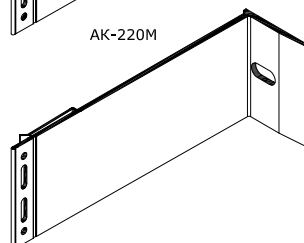

УК-М

